

The logo for USTALAR, featuring a stylized 'U' with a red and white swoosh, followed by the word 'USTALAR' in a bold, black, sans-serif font.

# USTALAR

F L O O R

A photograph of a decorative interior scene. In the foreground, there is a colorful, patterned rug with fringed edges. To the left, a white, ornate skirting board is visible. In the center-right, a black metal mesh candle holder contains a lit candle, and a small vase with white flowers sits next to it. The background is dark, suggesting a night setting.

## SKIRTING BOARDS

CATALOGUE 2023



## **ABOUT US**

As Kermit Plastic INC, we have been manufacturing plastic injection and extrusion molds for the last four decades. Kermit Floor can be seen as the culminating point of plastic mold making expertise.

Our company's subsidiary in Moldova first started producing skirting boards and related floor profiles almost twenty years ago, targeting the Eastern European and Russian markets with affordable products.



F L O O R

“Add value to your home and office”



# OUR VISION

## Growth that is:

- Intelligent (Based on Knowledge and Innovation)
- Sustainable (Resource Efficient and Competitive)
- Inclusive (High employment that supports the local ecosystem)

## Our Vision is:

To create an infrastructure for the reflection of energy and environmental awareness in design and material selection, to support recyclable materials, to produce products that are resistant to the geographical climate conditions and are not harmful to the nature.

To leave the world in a better condition to future generations by contributing to the formation of a sustainable, quality life culture.



# COLLECTIONS

## Composite Skirting Board

Water proof and impact resistant  
Flexible edges for uneven walls  
Cable channel hidden behind  
Smart one-click installation

**Moderna Collection**



**Optima Collection**

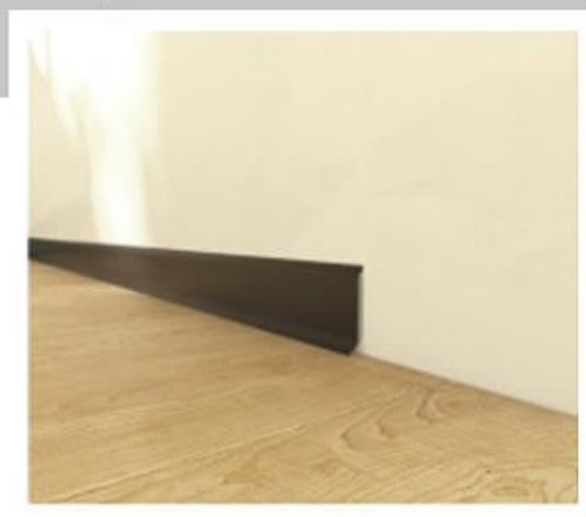

**Berlin Collection**



**Solid Collection**

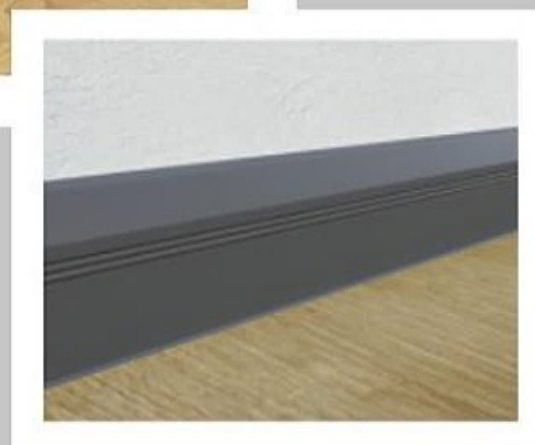











**Elite Collection**

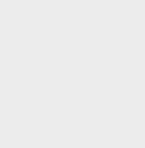
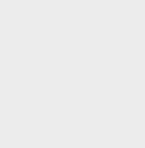











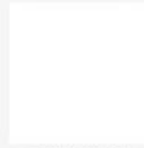

# RICH COLOR

## BERLIN 100

 1104031	 1105031	 1109031
 1112031	 1005031	 1006031
 1004031	 1005031	 1006031
 1009031	 1012031	 1010031

## MODERNA 100

## SOLID 80

 0904031	 0905031	 0909031	
 0910031	 0912031	 1005031	
 0604031	 0605031	 E1004031	 E1005031
 0612031	 0610031	 E1012031	 E1010031

## OPTIMA 60

## ELITE 100

## Cable Channel

Our installation rack also serves as an ideal cable tray to hide your permanent cables behind the skirting board.



PRODUCT



PRICE



QUALITY



DELIVERY



EFFICIENCY



# FEATURES

## **Flexible Edges**

Flexible edges take the shape of the wall and the floor to cover for any gaps arising out of unevenness in the walls. No need for filler!"



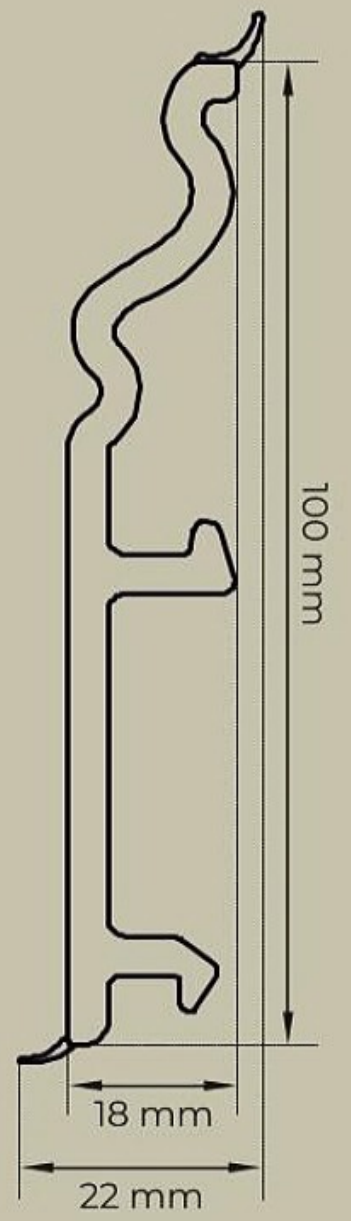

SCALE 1:1



# BERLIN 100

Our Berlin 100mm model is for those searching for a luxurious but classic look. As with our other models, Berlin 100 is 100% humidity resistant, it comes with a cable channel beneath and it's flexible edges cover for the unevenness in walls while eliminating the need to apply putty.



Berlin 1104031



Berlin 1105031



Berlin 1109031



Berlin 1112031

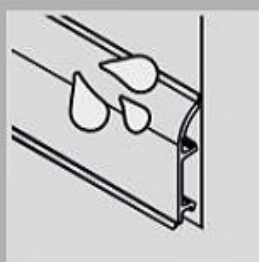

100%  
WATERPROOF



MITRE SAW



3 WAY SYSTEM

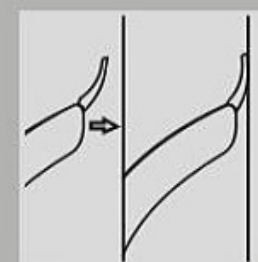

FLEXIBLE EDGES



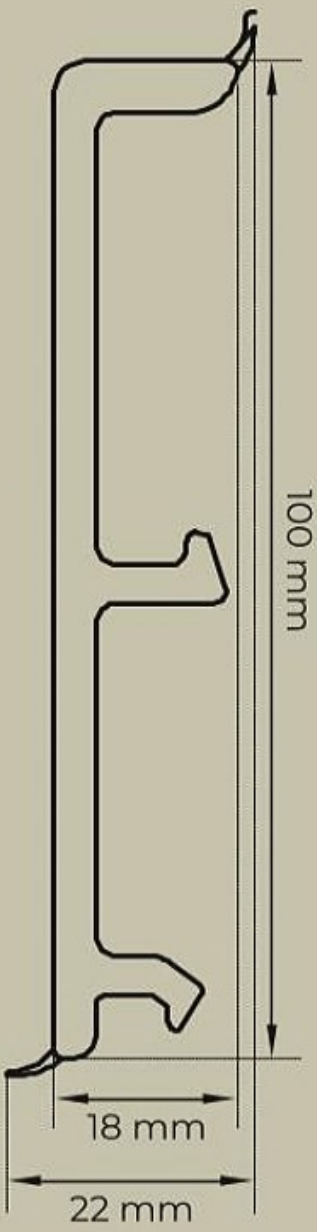

SCALE 1:1



# MODERNA 100

It contains flexible edges which cover any and all deficiencies on floors and walls. It's designed for those who like the rigid and modern look. Protective layers on it's top surface provide a very long life time.



Moderna 1004031



Moderna 1005031



Moderna 1006031



Moderna 1009031



Moderna 1012031



Moderna 1010031

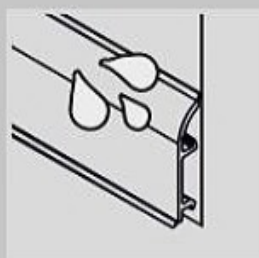

**100%  
WATERPROOF**



**MITRE SAW**



**3 WAY SYSTEM**

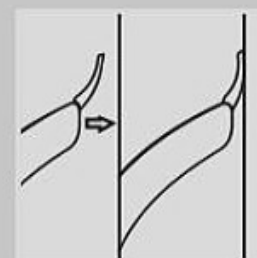

**FLEXIBLE EDGES**



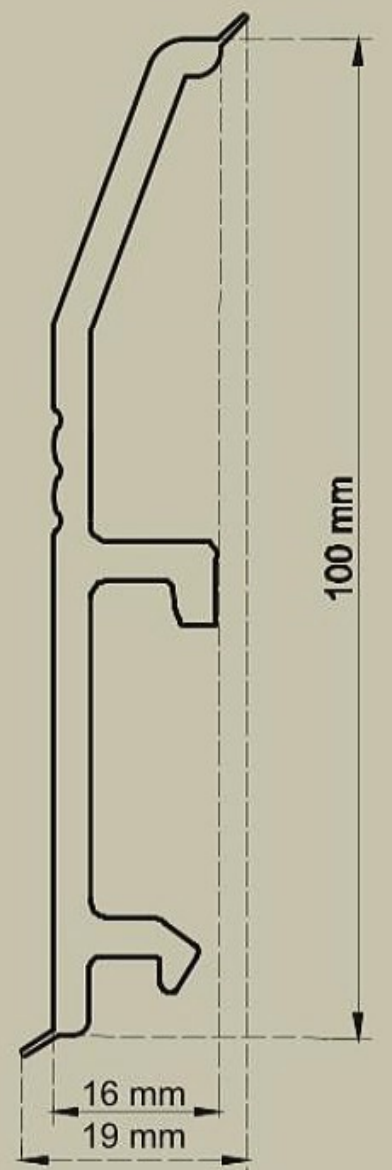

SCALE 1:1



# ELITE 100

Our Elite100 model is for those who seek a combination of modern lines and classic looks. Elite 100, while incorporating all features of its sister models, is assembled even faster due to not requiring the installation rack. Just simply glue it to the wall!



Elite E1005031



Elite E1012031



Elite E1009031



Elite E1004031

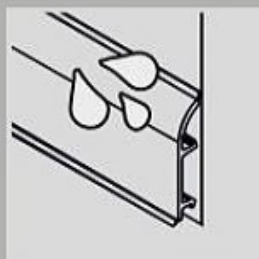

100%  
WATERPROOF



MITRE SAW



3 WAY SYSTEM

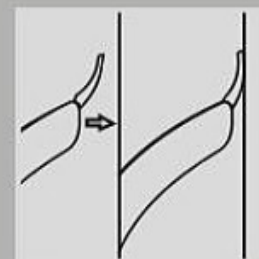

FLEXIBLE EDGES



## **SOLID 80**

Solid 80 is a perfect match for your mid to small rooms, offer a simple and elegant look. It is 100% humidity resistant. It comes with a cable channel and flexible edges to cover for the unevenness in walls and floors.





Solid 0904031



Solid 0905031



Solid 0909031



Solid 0910031



Solid 0912031

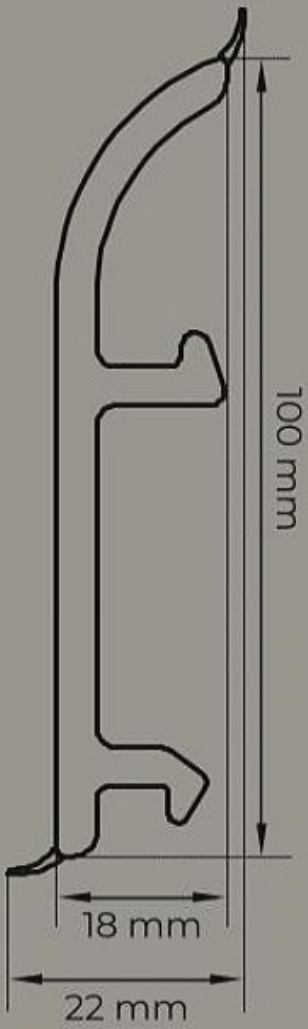

SCALE 1:1

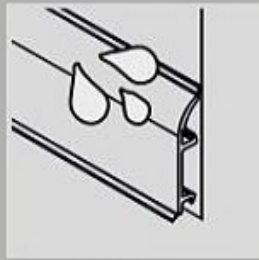

**100%  
WATERPROOF**

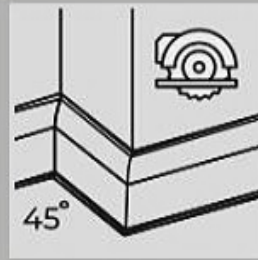

**MITRE SAW**



**3 WAY SYSTEM**



**FLEXIBLE EDGES**



# OPTIMA 60

With its 60mm height, easy adhesive mounting and its flexible edge that covers the gaps that result from the unevenness of the walls and floors OPTIMA is an aesthetic alternative as well as an affordable one.





SCALE 1:1

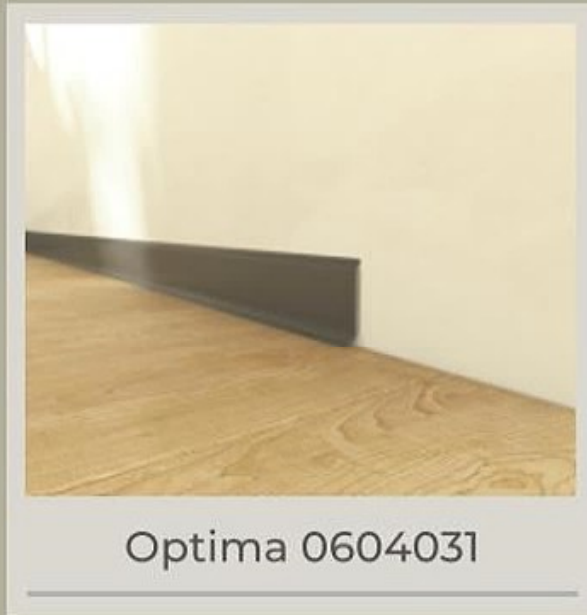

Optima 0604031

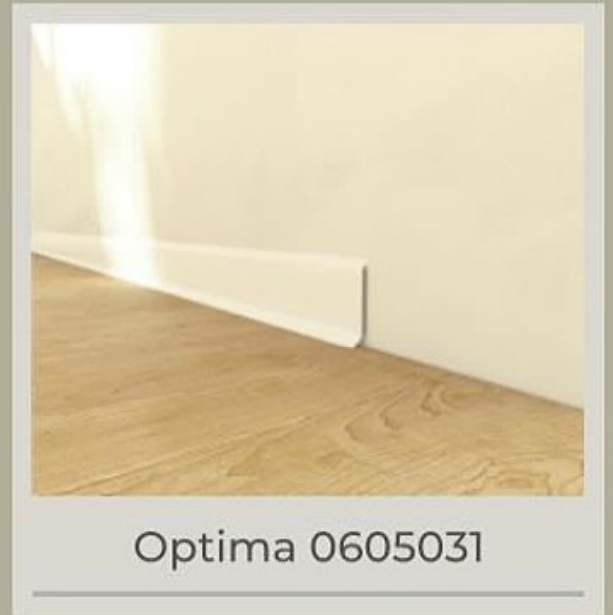

Optima 0605031



Optima 0612031

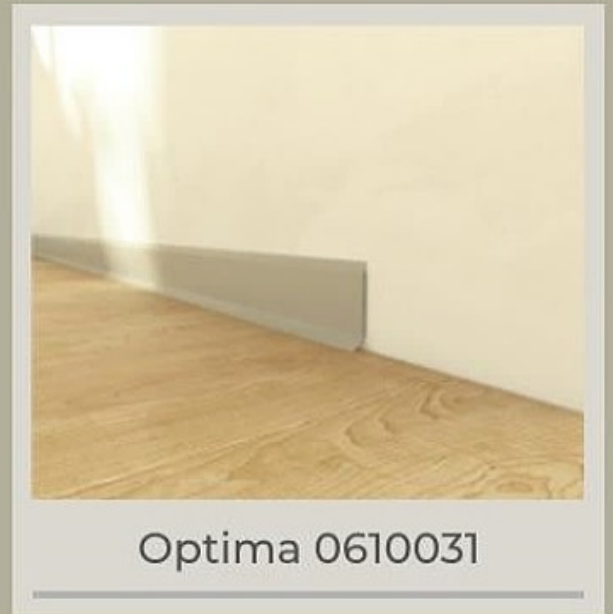

Optima 0610031

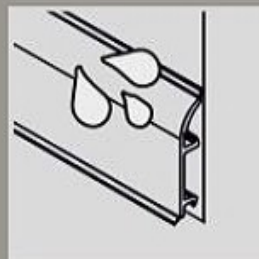

100%  
WATERPROOF



MITRE SAW



2 WAY SYSTEM



FLEXIBLE EDGES



# CORNER ACCESSORY

## UNIVERSAL BLOCK

Our products can be applied without an accessory by cutting 45 degrees. If you still wish to use an accessory, we have the perfect one size fits all solution.

Comes with multiple color options. Can be cut from bottom to reduce it's height.

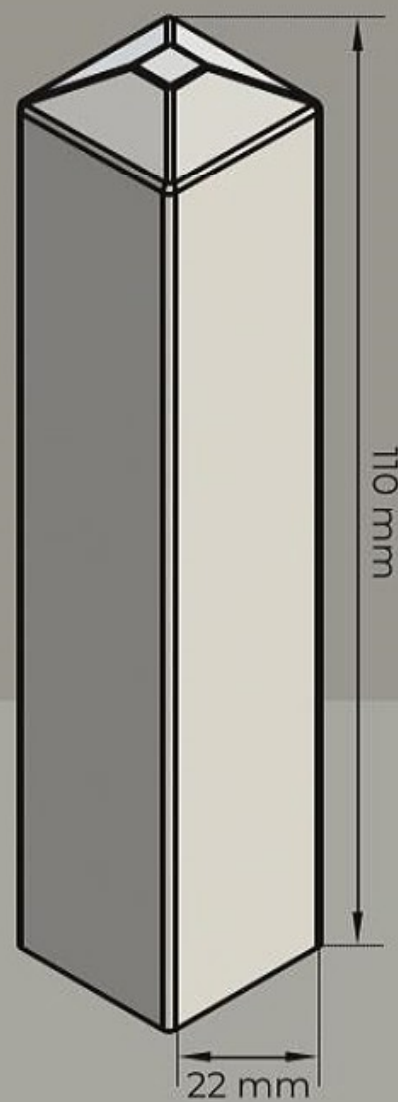
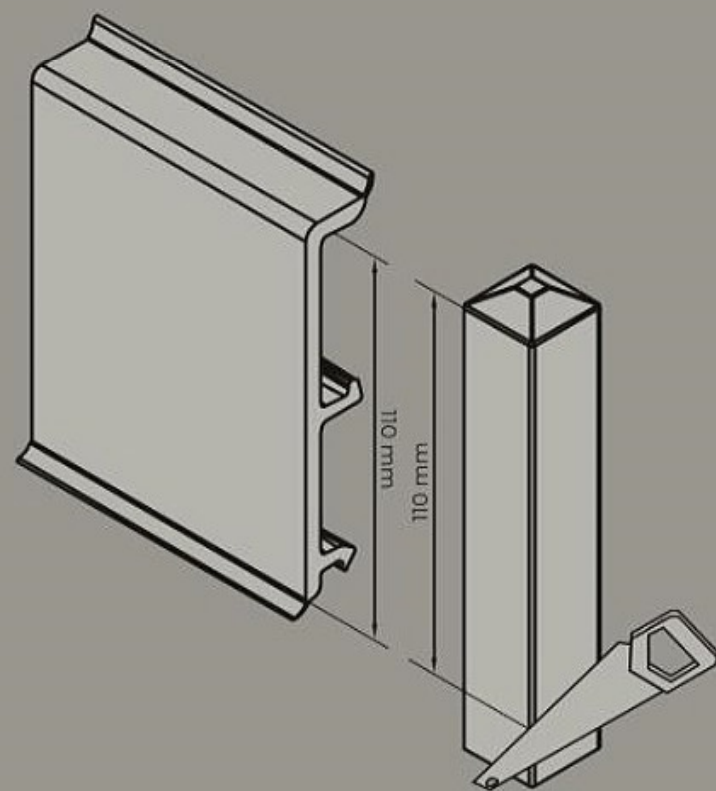

SCALE 1:1







# ALL IN ONE

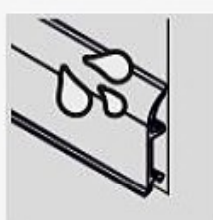

## 100% WATERPROOF

Clean your floor without any risk - non-deforming, water resistant board!

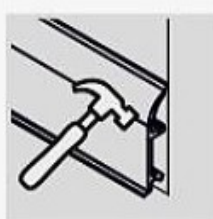

## IMPACT RESISTANT

Highest resistance and stability.



## MULTIPLE COLORS

The board which can be painted. Possibility of fully matching the board colors to the walls of the room.



## MATT SURFACE

Thanks to totally new, multi-step process of production we get a matt surface.



## BENDABLE

Flexible adaption to uneven walls.

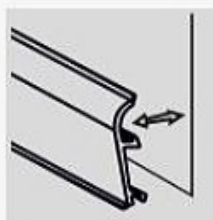

## EASY WALL RENOVATION

Possibility of unfixing skirtings in order to paint or hide TV or audio cable (max 230V).



## ECO FRIENDLY

The board made of environmentally friendly material.



## 3 WAY SYSTEM

Solid, fast, simple installation and deinstallation, for any type of wall.



## SMART INSTALLATION

Wide installation channel provides an easy access for a drill or screwdriver. It makes installation quicker and easier.



## MITRE SAW

The possibility of cutting corners with a mitre saw.



## DUST AND DIRT BARRIER

Smooth surface without micropores and harder COEX is perfect for easy cleaning and non adhering dirt and dust.

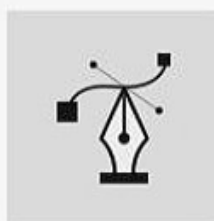

## MODERN DESIGN

Unique shape was created for a modern interiors and its simplicity is an answer even for the most demanding.

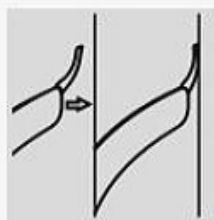

## FLEXIBLE EDGES

Flexible edges take the shape of the wall and the floor so you don't need to use filler!



## PROTECTIVE FOIL

Protective foil removable after renovation.



F L O O R

Water Proof

No Silicone Needed

Flexible Edges

Cable Channel

Smart Installation

Composite Structure



F L O O R

### KERMIT ECO FRIENDLY

KERMIT FLOOR Skirting Boards are respectful to nature, Pb free and made from completely recyclable material. Considering the fact that our products can be recycled multiple times during their lifespan, eco-friendly nature of our products can be easily understood. In addition, our products do not need painting and can be used for a much longer time period than alternatives



skirting board made of environmentally friendly material

[kermitfloor.com](http://kermitfloor.com)



## CONTACT

+ 90 532 466 6068

ceo@ustalar.com

www.ustalar.com

Yakuplu Mahallesi 124 sk no:21 / B BEYLUKDUZU / ISTANBUL / TÜRKİYE